

**FERROXCUBE**

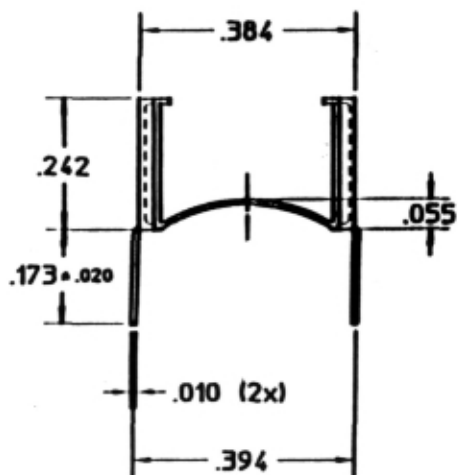
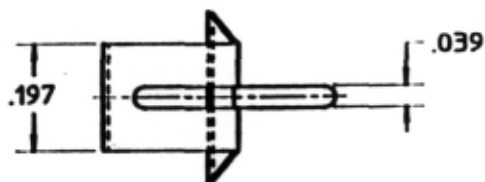
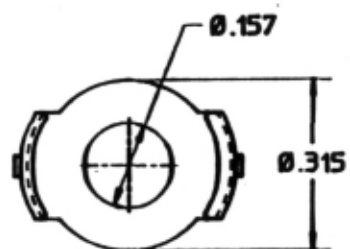
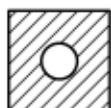
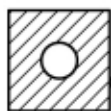

Material: Phosphor bronze, Sn plated (0.008" thk)

			01-06-01
	<b>CLM/TP-P9/5</b>	<b>4335 000 26131</b>	