

**FERROXCUBE**

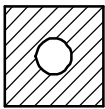

1 2 3 4

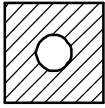
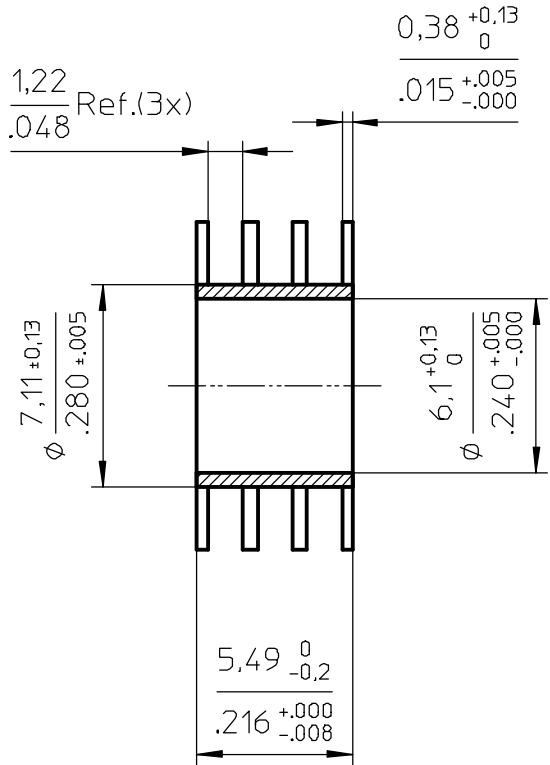
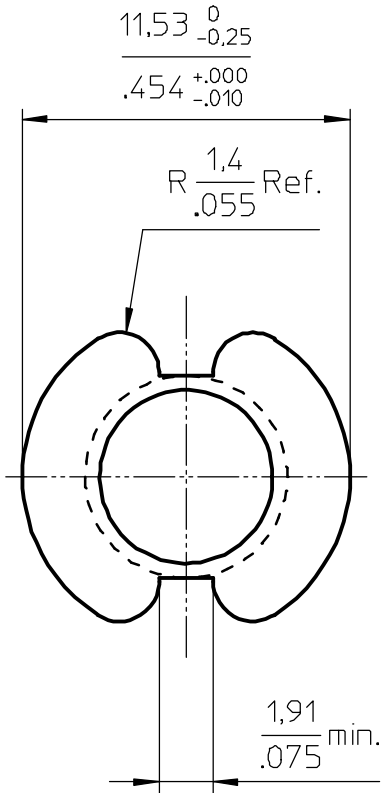

Coil former material: Delrin 900 (POM).  
 UL file number: E66288 - UL94HB.

CP-P14/8-3S-A

4335 000 26061

01-06-01  
 02-11-04

NAME NAAM	JON	SUPERS. VERV.	1	SH BL	SH BL	112 - 001	<b>A4</b>
MPA	CHECK CONTR.	DAT.	Property of Eigendom van		© FERROXCUBE 2002		