

MOUNTING PARTS

General data for mounting parts

ITEM	REMARKS	FIGURE	TYPE NUMBER
Tag plate	material: phenolformaldehyde (PF), glass reinforced	7	TGP-P14/8-C
	flame retardant: in accordance with "UL 94V-0"; UL file number E41429		
	maximum operating temperature: 180 °C, "IEC 60085", class H		
	pins: copper-tin alloy (CuSn), tin (Sn) plated		
	resistance to soldering heat in accordance with "IEC 60068-2-20", Part 2, Test Tb, method 1B: 350 °C, 3.5 s		
	solderability in accordance with "IEC 60068-2-20", Part 2, Test Ta, method 1: 235 °C, 2 s		
Container	copper-zinc alloy (CuZn), tin (Sn) plated	8	CON-P14/8
	earth pins: presoldered		
Spring	CrNi-steel	9	SPR-P14/8
	spring force: ≈60 N when mounted		
Clamp	spring steel, tin-plated	10	CLM/TP-P14/8
Washer	phenolformaldehyde (PF)	11	WAS-CLM/TP-P14/8

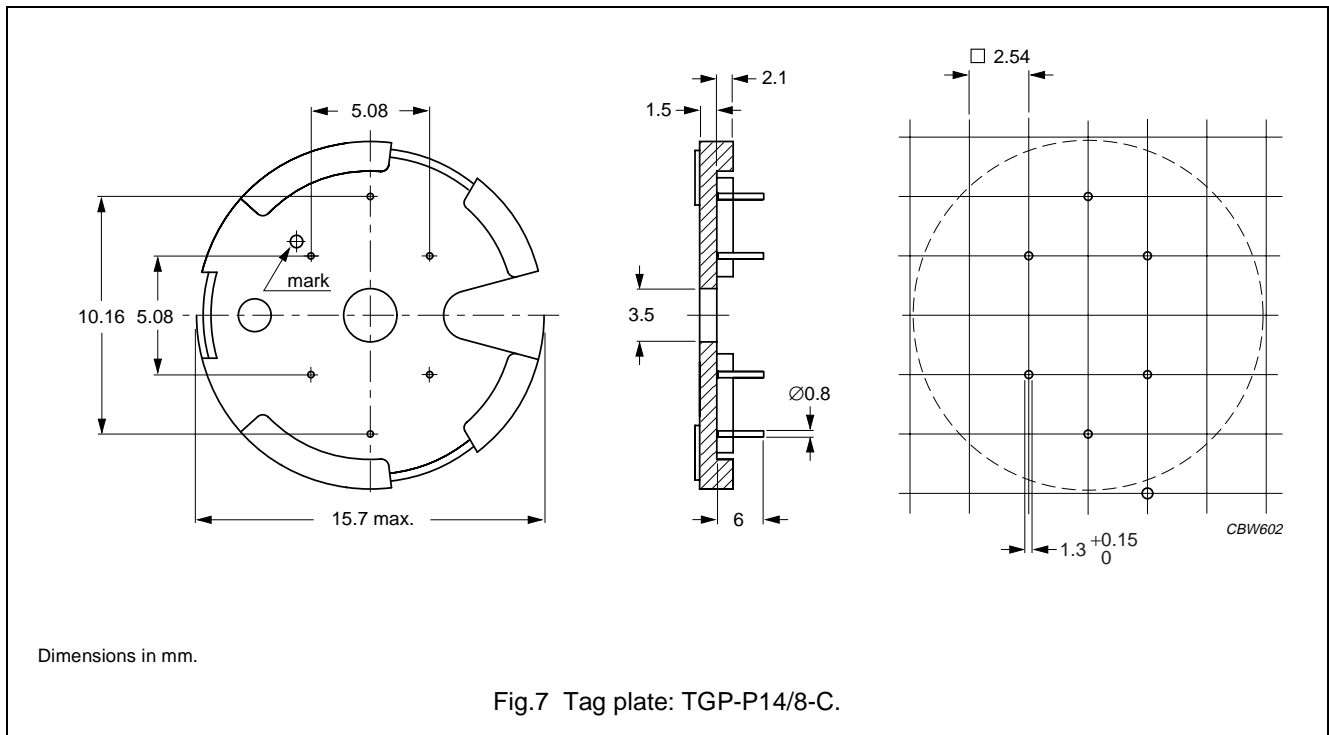

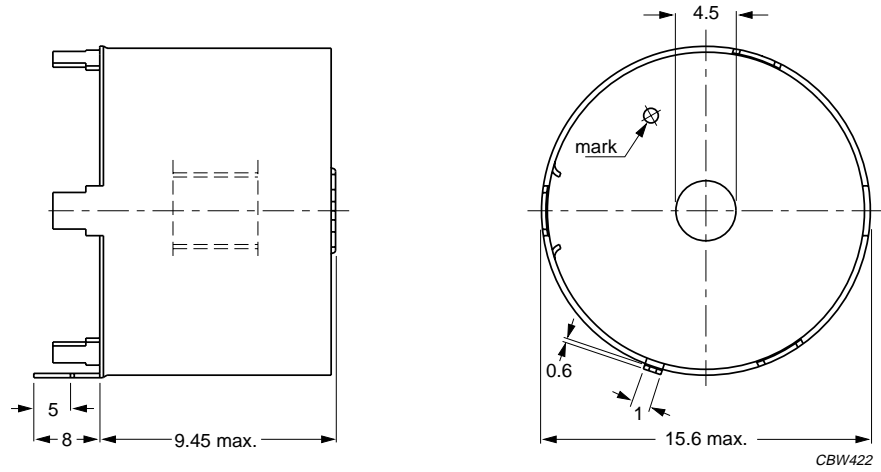

Dimensions in mm.

Fig.8 Container: CON-P14/8.

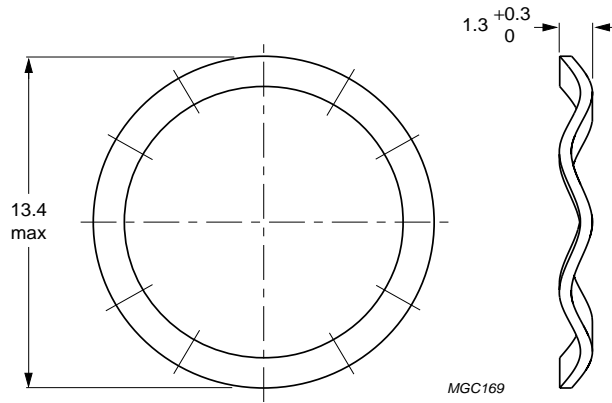

Dimensions in mm.

Fig.9 Spring: SPR-P14/8.

