

HOLE PATTERN:

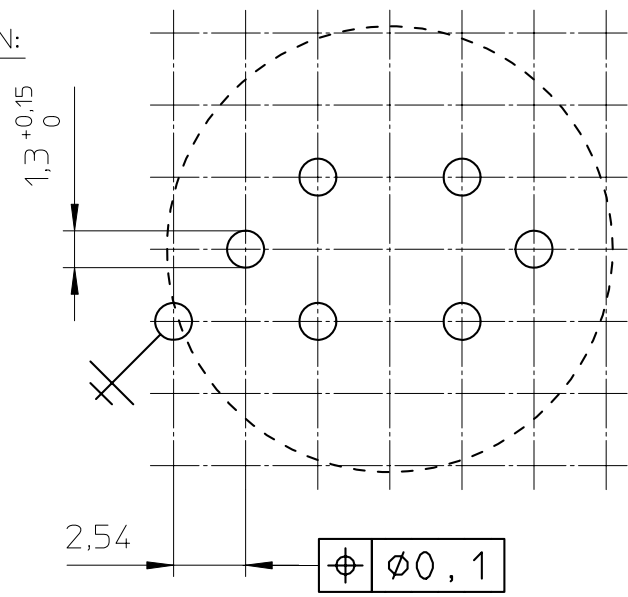

Tag plate material: Sumikon PM9630 (PF), glass-reinforced.

UL filenumber: E41429 - UL94V-0.

Pin material: Copperclad steel, Sn plated.

Max. operating temp.: 180°C.

Resistance to soldering heat: 430°C - 2sec.

Solderability: IEC 68-2-20 Part 2, Test Ta, method 1.

CLASS.NO.		TGP-P14/8-C		4322 021 04261		02-07-09		
						06-02-22		
NAME NAAM	A.Wojtasz	SUPERS. VERV.		1	SH BL.	112 - 001	010	A4
MPA	CHECK CONTR.	DAT.	2002-07-09	Property of Eigendom van		© FERROXCUBE 2000		